

深圳市色彩光电有限公司  
**Shenzhen LED Color Opto Electronic Co.,ltd**

Factory Address 1:5th floor Dadong Ming Science and Technology Park Yuequn road Changzhen Viliage Guangming New District Shenzhen  
Factory Address 2:2th floor Changxing Technology Industrial Park Chanzhen Viliage Guangming New District Shenzhen  
Tel:+86-0755-27350605 Fax:+86-0755-2324-5913

**LC-50RGBX-XX**  
**SPECIFICATION**

Document No.: SPC/ LC-50RGBX-XX

Model No.: LC-50RGBX-XX

Description: 5.5x5.0x1.6mm Top SMD Type 4-chips 0.4 Watt Power  
RGBW Flash Color LED

Material: InGaN or AlInGaP Chip Inside

Rev. No.: 03

Date: 2015-11-04

**Formal Specification**



**SPECIFICATION OF CHIP**

---

**Model: LC-50RGBX-XX**

These SMD LEDs are packaged in the industry standard CLPP6 package. These high-reliability and high-brightness LEDs are designed to work in a wide range of environmental conditions and are ideally suited for use in illumination applications. Their wide viewing angle makes these LEDs ideally suited for channel letter, or general backlighting and illumination applications. The flat top emitting surface makes it easy for these LEDs to mate with light pipes. All components are produced by packing high-performance LED chips and silicon resin with proprietary phosphors.

**1. Features and Benefits**

- . Ideal for LED lighting application to avoid multi-shadows
- . Higher heat conductivity for better thermal management
- . Provide variable and innovative array LED layout designs and combinations
- . Reduce the initial development cost and time
- . High lumen-performance per dollar cost
- . Lead free reflow solder compatible with RoHS compliant

**2. Applications**

- . Light Strip
- . Channel Letter
- . Backlight

**3. Dimensions and Materials**

- . Dimensions: 5.5 mm x 5.0 mm x 1.6 mm
- . Packages: Top SMD
- . Capsulated Resin: Silicone Resin with Aluminate Phosphor
- . Electrodes: Ag Plating
- . Chips: Total 4 chips packed in a cavity

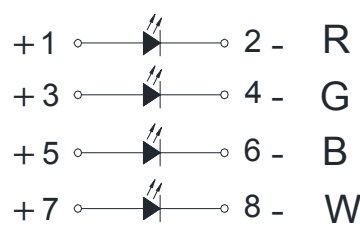
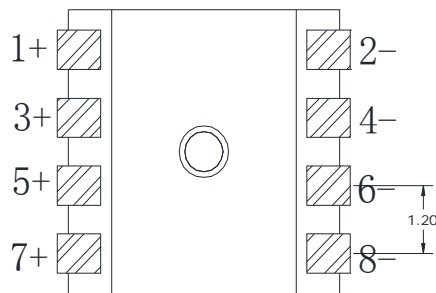
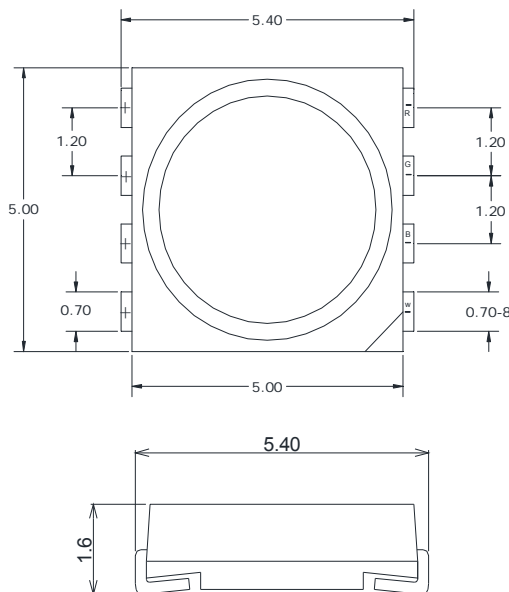

**Notes:**

1. All dimensions are in millimeters.
2. Tolerance is  $\pm 0.1$ mm unless otherwise noted

### 3. General Information

# LC-50 RGBX -XX

LC50: 5.5x5.0x1.6mm

RGBX:

R 620-625NM  
G 517.5-520NM  
B 467.5-470NM

X: W White Color

Y 590-595nm

XX: BW Blue White 6000-7000K  
NW Natural White 4000-5000K  
WS Warm Sunlight 2800-3200K

Note : Typical CRI for White (2400 K – 7500 K CCT) is 90.

**深圳市色彩光电有限公司**  
**Shenzhen LED Color Opto Electronic Co.,ltd**

---

**4. Absolute Maximum Ratings**

(Thermal Pad Temperature @25°C)

ITEM		SYMBOL	ABSOLUTE MAXIMUM RATING	UNIT
Power Dissipation	White	Pd	0.072	W
	Red/Amber		0.048	
	Green		0.072	
	Blue		0.072	
D.C Forward Current		If	20	mA
Pulse Forward Current (*1)		I <sub>fp</sub>	100	mA
Thermal Resistance , Junction-Case (*2)		R <sub>θj-c</sub>	230	°C/W
Reverse Voltage		V <sub>r</sub>	5	V
Operating Temperature		T <sub>opr</sub>	- 20~+65	°C
Storage Temperature		T <sub>stg</sub>	- 40~+100	°C
Soldering Temperature (Reflow) (*3)		T <sub>sld</sub>	max.240 < 5sec	°C

\*1: I<sub>fp</sub> conditions: 1/10 Duty Cycle & 0.1ms for pulse width.

\*2: R<sub>th</sub> test condition: Mounted on PC Board FR 4 (pad size ≥ 40mm<sup>2</sup>)

\*3: Reflow method: 1.2mm MCPCB from body for 5 seconds not exceeding the recommended maximum temperature.

深圳市色彩光电有限公司  
Shenzhen LED Color Opto Electronic Co.,ltd

**5. Electrical/Optical Characteristics**

**. Forward Voltage**

(Thermal Pad Temperature @25°C)

Color	SYMBOL	TEST CONDITIONS	MIN.	TYP.	MAX.	UNIT
White	Vf	If=20 mA	3.1	3.2	3.4	V
YELLOW		If=20 mA	2.1	2.2	2.3	V
Red		If=20 mA	2.1	2.2	2.3	V
Green		If=20 mA	3.1	3.2	3.3	V
Blue		If=20 mA	3.1	3.2	3.3	V

**. Reverse Current**

(Thermal Pad Temperature @25°C)

Color	SYMBOL	TEST CONDITIONS	MIN.	TYP.	MAX.	UNIT
White	IR	VR=5 V	--	--	5	μA
Yellow		VR=5 V	--	--	5	μA
Red		VR=5 V	--	--	5	μA
Green		VR=5 V	--	--	5	μA
Blue		VR=5 V	--	--	5	μA

**. Luminous Flux**

(Thermal Pad Temperature @25°C)

Color	SYMBOL	TEST CONDITIONS	MIN.	TYP.	MAX.	UNIT
White	Φv	If=20 mA	6.0	7.0	--	lm
Yellow		If=20 mA	1.0	2.0	--	lm
Red		If=20 mA	1.0	2.0	--	lm
Green		If=20 mA	4.0	6.0	--	lm
Blue		If=20 mA	1.0	2.0	--	lm

**. Color Temperature or Dominate Wavelength**

(Thermal Pad Temperature @25°C)

Color	SYMBOL	TEST CONDITIONS	MIN.	TYP.	MAX.	UNIT
Yellow	λd	If=20 mA	--	590	--	nm
Red		If=20 mA	--	622	--	nm
Green		If=20 mA	--	520	--	nm
Blue		If=20 mA	--	468	--	nm

**8. 1 Optical-Electrical Characteristic Graphs (InGaN)**

Typical Relative Luminous Flux vs. Forward Current

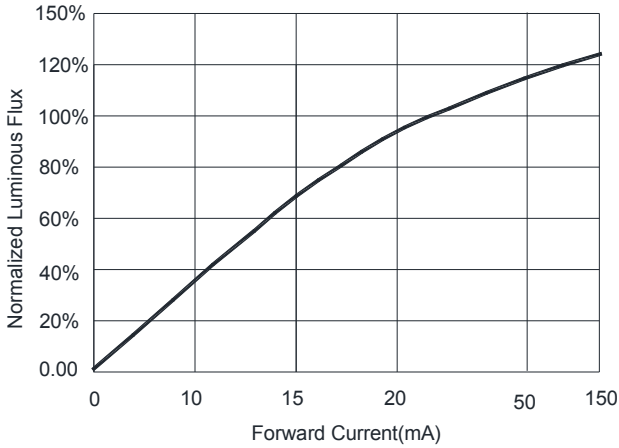

Forward Voltage vs. Forward Current

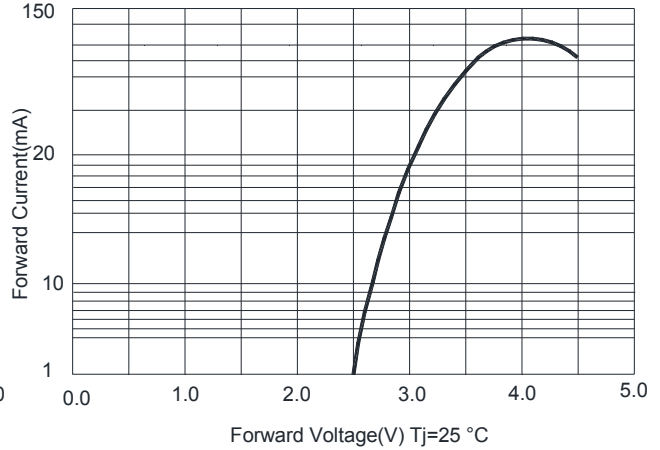

Thermal Pad Temperature vs. Relative Light Output

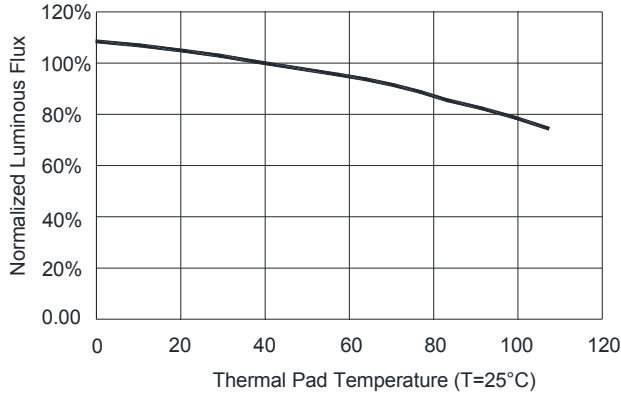

Wavelength Characteristics

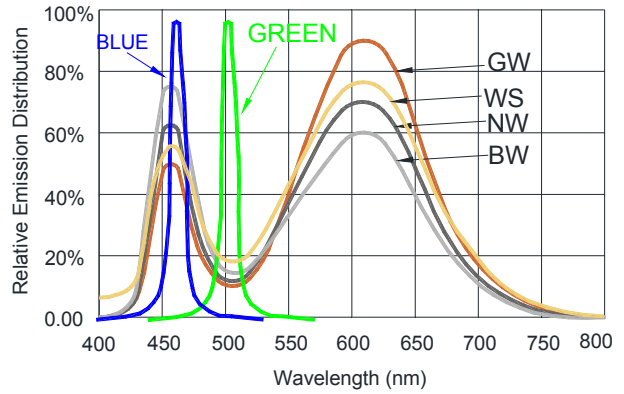

Thermal Pad Temperature vs. Forward Current

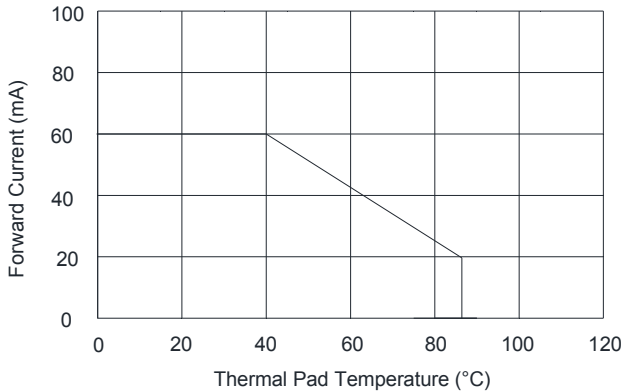

Typical Radiation Pattern 120°

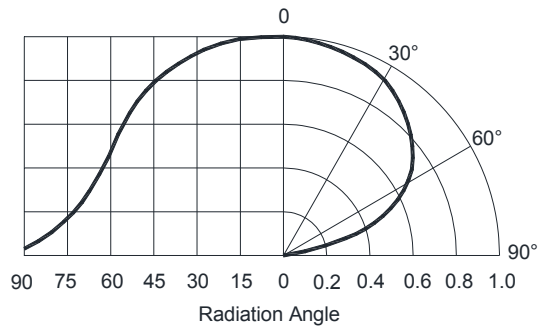

**8.2 Optical-Electrical Characteristic Graphs (AlInGaP)**

Typical Relative Luminous Flux vs. Forward Current

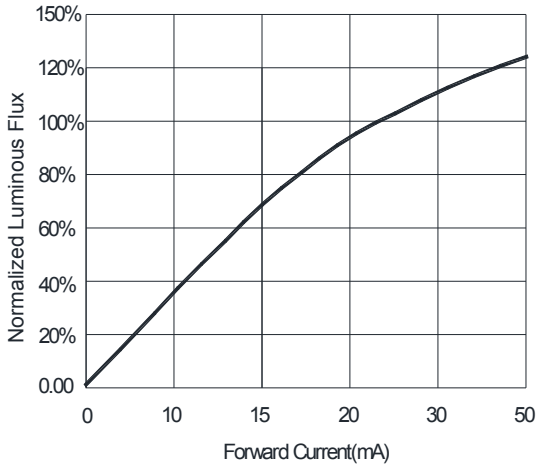

Forward Voltage vs. Forward Current

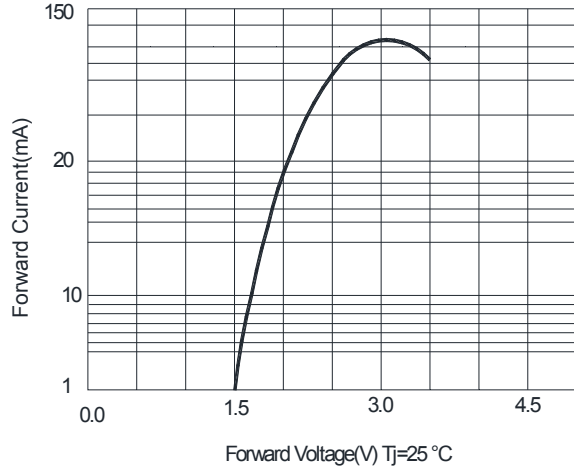

Thermal Pad Temperature vs. Relative Light Output

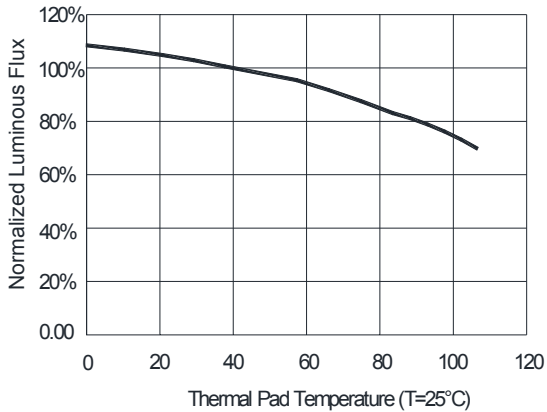

Wavelength Characteristics

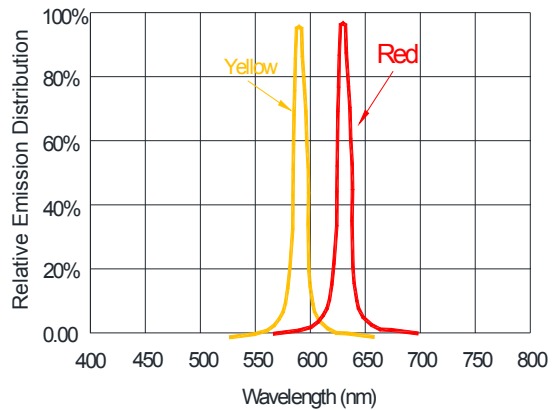

Thermal Pad Temperature vs. Forward Current

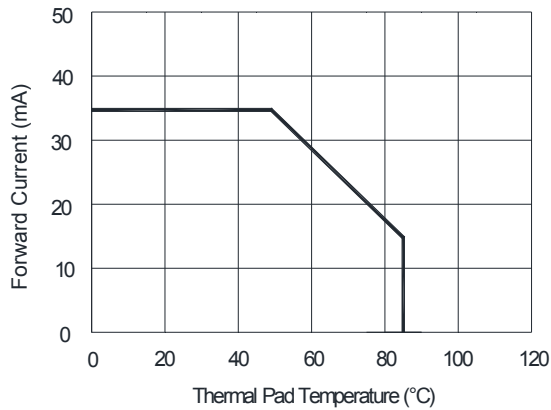

Typical Radiation Pattern 120°

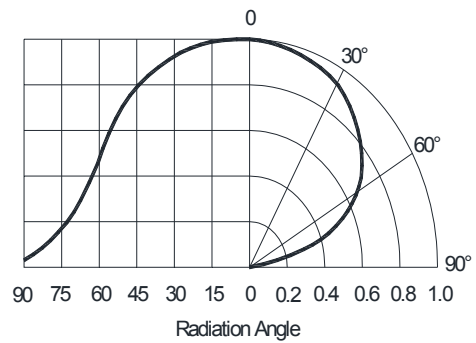

**深圳市色彩光电有限公司**  
**Shenzhen LED Color Opto Electronic Co.,ltd**

**9. Packaging Standard:**

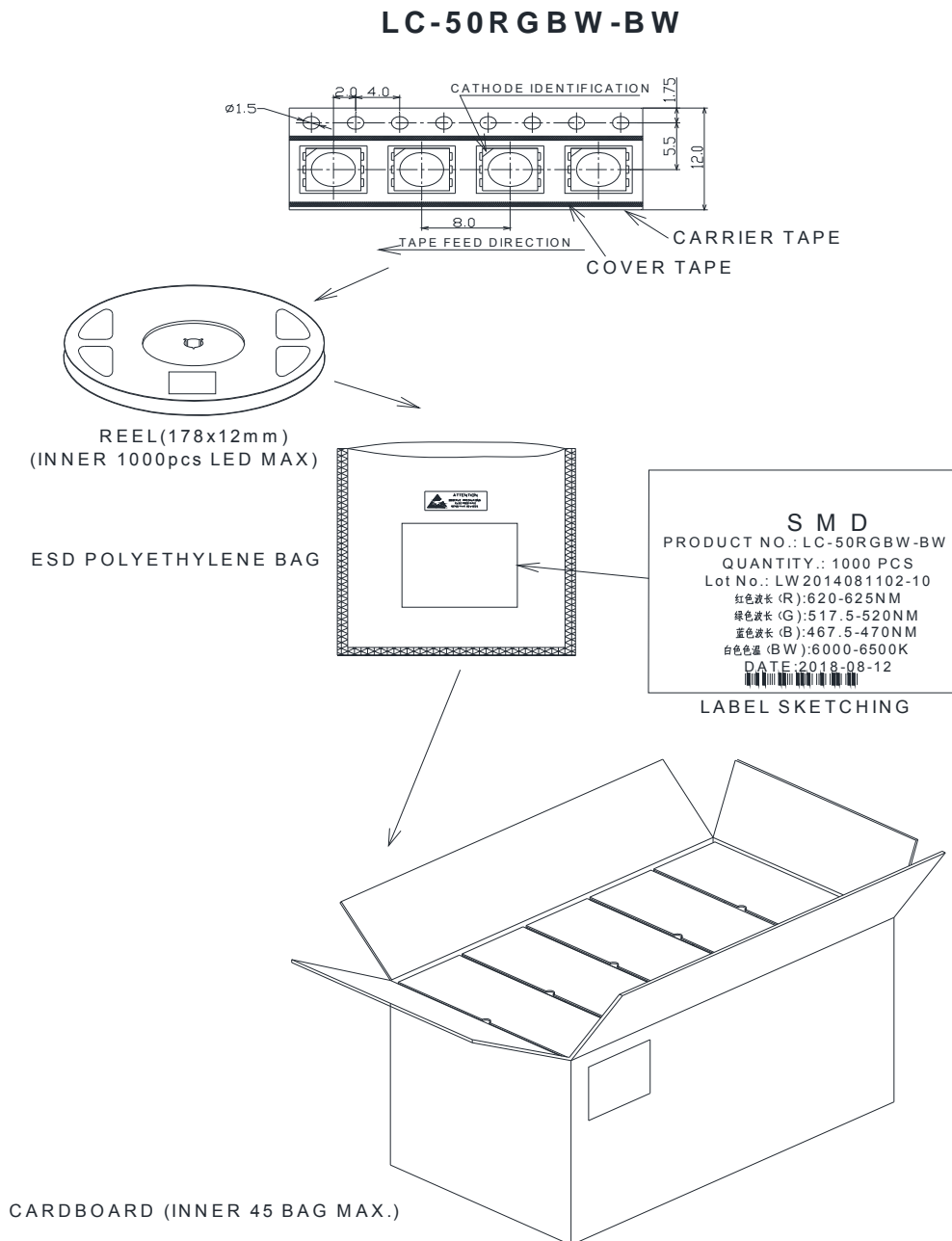

The reel pack is applied in SMD LED. The LEDs are packed in cardboard boxes after packaging in normal or anti-electrostatic bags. cardboard boxes will be used to protect the LEDs from mechanical shocks during transportation. The boxes are not water resistant and therefore must be kept away from water and moisture.



# 深圳市色彩光电有限公司

## Shenzhen LED Color Opto Electronic Co.,ltd

---

### 1. Features

The Purposes of making customers and users to have a clear understanding on the ways how to use the LED.

### 2. Description

Generally, The LED can be used the same way as other general purposed semiconductors. When using SMD LED, the following precautions must be taken to protect the LED.

### 3. Cautions

#### 3.1. Dust & Cleaning

This emitter has a silicone surface, There are many benefits to the silicone surface in terms of optical properties and improved reliability. However, silicone is a softer material and prone to attract dust. While a minimal amount of dust and debris on the LED will not cause significant reduction in illumination, steps should be taken to keep the emitter free of dust.

These include keeping the LEDs in the manufacturer's package prior to assembly and storing assemblies in an enclosed area after installing the emitters.

Surface condition of this device may change when organic solvents such as trichloroethylene or acetone were applied.

Avoid using organic solvent, it is recommended that isopropyl be used as a solvent for cleaning the LEDs. When using other solvents, it should be confirmed beforehand whether the solvents will dissolve the package and the resin of not.

Do not clean the LEDs by the ultrasonic. When it is absolutely necessary, the influence as ultrasonic cleaning on the LEDs depends on factors such as ultrasonic power. Baking time and assembled condition. Before cleaning, a pre-test should be done to confirm whether any damage to the LEDs will occur.

#### 3.2. Moisture Proof Package

In order to avoid the absorption of moisture during transportation and storage, LED are packed in the aluminum envelop, A desiccant is included in the aluminum envelop as it absorbs moisture. When moisture is absorbed into the AMT package it may vaporize and expand during soldering. There is a possibility that this can cause exfoliation of the contacts and damage to the optical characteristics of the LEDs. For this reason, the moisture proof package is used to keep moisture to a minimum in the package.

#### 3.3. Storage

In order to avoid the absorption of moisture, It is recommended to store SMD LED (in bulk or taped) in the dry box (or the desiccator ) with a desiccant, Otherwise to store them in the following environment as recommended.

a. Temperature: 5°C~30°C

b. Humidity: 60% RH Max

It is recommended to solder the LED as soon as possible after unpacking the aluminum envelop, But in case that the LED have to be left unused after unpacking envelop again is requested.

The LED should be soldering within 1 hours after opening the package.

If baking is required, A baking treatment should be performed as follows:

70°C±5°C for more than 24 hours.

### 3.4. Reflow Soldering Characteristics

In testing, LC-5050RGBW LEDs to be compatible with JEDEC J-STD-020C, using the parameters listed below. As a general guideline OPSCO recommends that users follow the recommended soldering profile provided by the manufacturer of solder paste used.

Note that this general guideline is offered as a starting point and may require adjustment for certain PCB designs and Configurations of reflow soldering equipment.

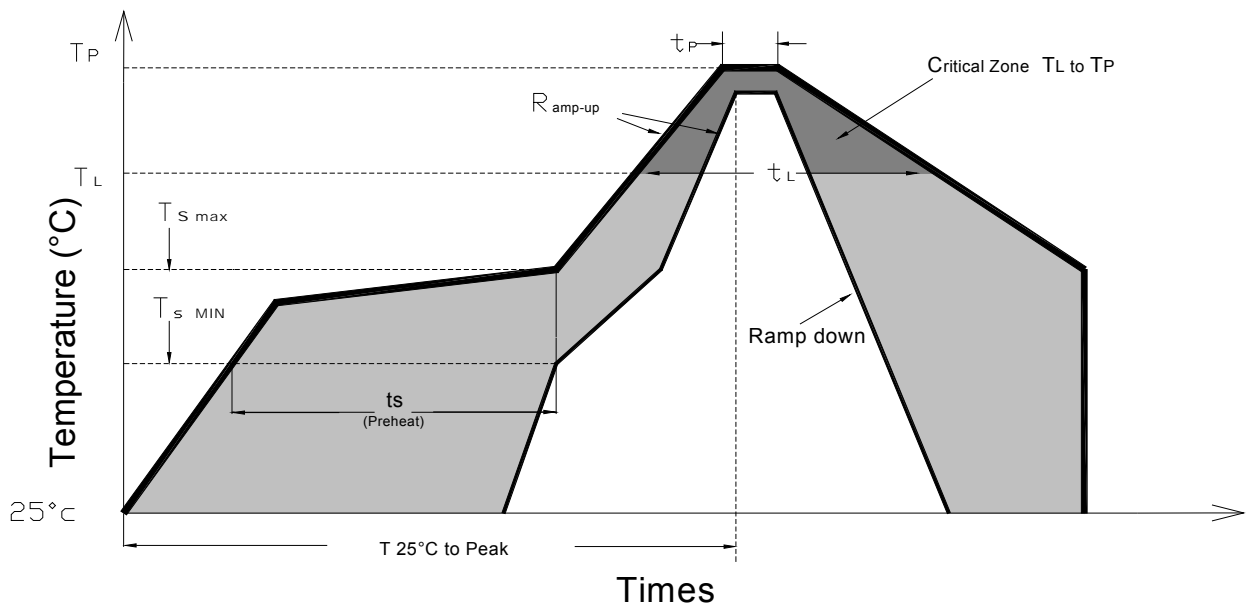

Profile Feature	Lead-Based Solder	Lead-Free Solder
Average Ramp-Up Rate ( $T_{s\ max}$ to $T_p$ )	3°C/second max.	3°C/second max.
Preheat: Temperature Min ( $T_{s\ min}$ )	100°C	150°C
Preheat: Temperature Min ( $T_{s\ max}$ )	150°C	200°C
Preheat: Time ( $t_{s\ min}$ to $t_{s\ max}$ )	60-120 seconds	60-180 seconds
Time Maintained Above: Temperature ( $T_L$ )	183 °C	217 °C
Time Maintained Above: Time ( $t_L$ )	60-150 seconds	60-150 seconds
Peak/Classification Temperature ( $T_p$ )	215 °C	240 °C
Time Within 5°C of Actual Peak Temperature ( $t_p$ )	<10 seconds	<10 seconds
Ramp-Down Rate	6°C/second max.	6°C/second max.
Time 25 °C to Peak Temperature	<6 minutes max.	<6 minutes max.

Note: All temperatures refer to topside of the package, measured on the package body surface.

### **3.5. Heat Generation**

Thermal design of the end product is of paramount importance. Please consider the heat generation of the LED when making the system design. The coefficient of temperature increase per input electric power is affected by the thermal resistance of the circuit board and density of LED placement on the board, as well as components. It is necessary to avoid in tense heat generation and operate within the maximum rating given in this specification. The operating current should be decided after considering the ambient maximum temperature of LEDs

### **3.6. Electrostatic Discharge & Surge Current**

Electrostatic discharge (ESD) or surge current (EOS) may damage LED.

Precautions such as ESD wrist strap, ESD shoe strap or antistatic gloves must be worn whenever handling of LED.

All devices, equipment and machinery must be properly grounded.

It is recommended to per form electrical test to screen out ESD failures at final inspection.

It is important to eliminate the possibility of surge current during circuitry design.

### **3.7. Other**

Can not take any responsibility for any trouble that are caused by using the LEDs at conditions exceeding our specifications.

These LEDs are designed and manufactured for standard applications such as electric home appliances, communication equipment, office equipment, electronic equipment and so on.

It is recommended to consult us in advance if user's application requires any particular quality or reliability which concerns human life. Examples would be medical equipment, aerospace applications, traffic signals, safety system equipment and so on.

Care must be taken to ensure that the reverse voltage will not exceed the absolute maximum rating when using the LEDs with matrix drive.

The LED light output is strong enough to injure human eyes. Precautions must be taken to prevent looking directly at the LEDs with unaided eyes for more than a few seconds.

The formal specification must be exchanged and signed by both parties before large volume purchase begins.

The appearance and specifications of the product may be modified for improvement without notice.

